

HabasitLINK[®]

Installation instructions for belt types M0870 and M0870 MTW

Please find full installation guide on www.habasitlink.com

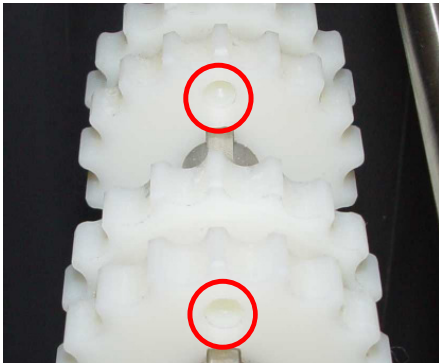

Sprocket alignment on the shafts:

Corresponding teeth axial aligned, check by alignment mark.

If the bore is square and the number of teeth can be divided by 4, there may be no mark.

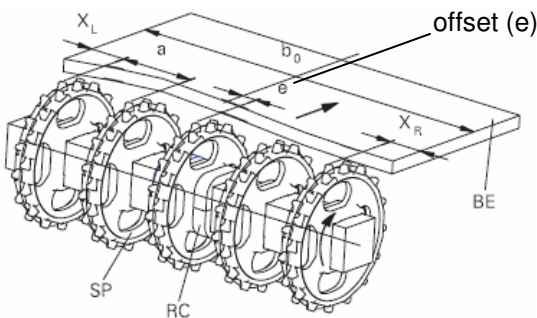

Sprockets Positioning:

Place sprockets between min. and max. spacing (a).

Place outer most sprockets at first position from edge and respect distance X_L and X_R .

Fix only the sprocket in the center with small clearance.

Belt type	Sprocket spacing a		Edge distance (minimal)	
	minimal mm inch	maximal mm inch	X_L mm inch	X_R mm inch
M0870	50.8 2	152.4 6	25 1	25 1
M0870 MTW	50.8 2	152.4 6	38 1.5	38 1.5

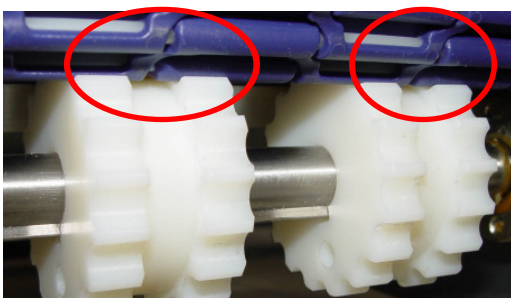
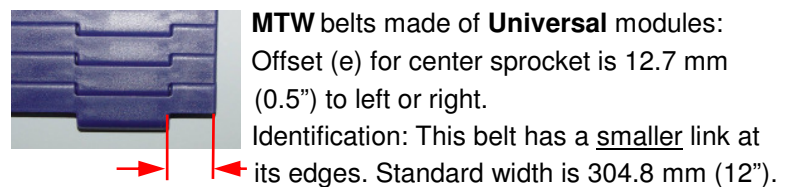
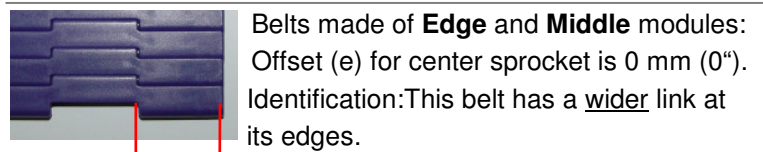

Check proper sprocket engagement:

The double teeth sprocket must properly engage in belt.

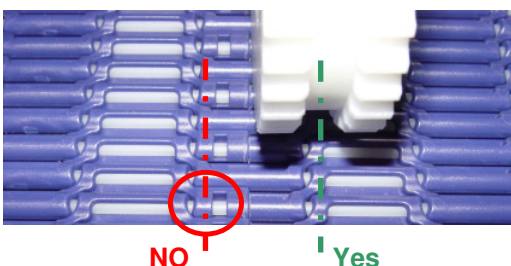

If a brick layered belt is assembled with universal modules the sprockets must not be placed at **rod retaining** module end (red line).

Rod installation (snap fit rod retention):

Use headless rods $\text{Ø}3.0\text{mm}$ (0.12") with retainer ring and beveled rod end.



Beveled rod end

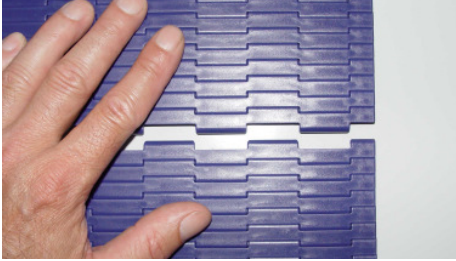

Pull belt sections together

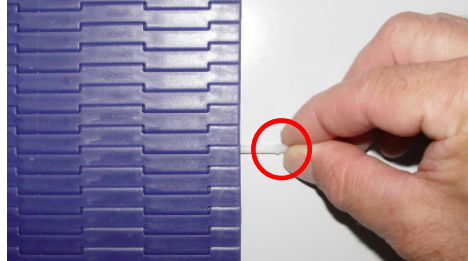

Insert rod. For easy rod installation, rod end must be beveled.

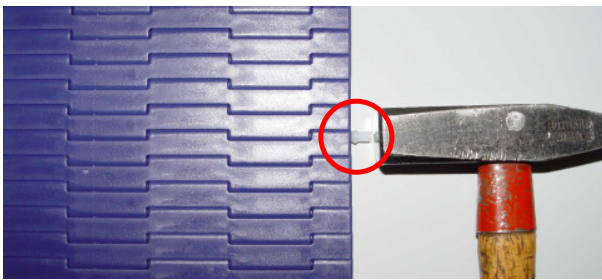

Hammer in rod

Check if **rod is fully embedded** (proper snapped in).

Rod removal (snap fit rod retention):

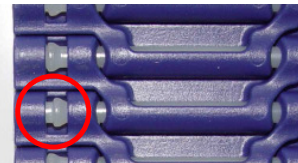

Find belt side with rod retaining ring

Punch rod out from this side

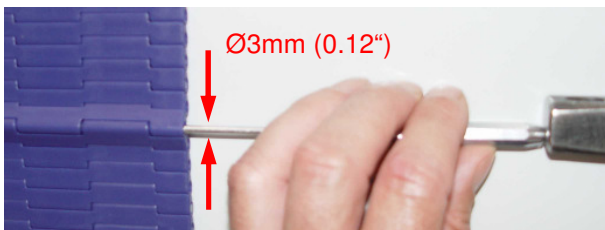

Rod removal (by hammer and punch)

Punch out of rod retaining ring by striking rod end **opposite to retaining ring**.

The belt must not be under tension.

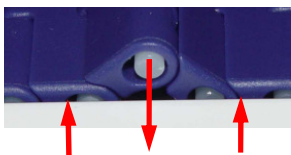

Hold back module edge on the opposite side.

Product liability, application considerations

If the proper selection and application of Habasit products are not recommended by an authorized Habasit sales specialist, the selection and application of Habasit products, including the related area of product safety, are the responsibility of the customer. All indications / information are recommendations and believed to be reliable, but no representations, guarantees, or warranties of any kind are made as to their accuracy or suitability for particular applications. The data provided herein are based on laboratory work with small-scale test equipment, running at standard conditions, and do not necessarily match product performance in industrial use. New knowledge and experiences can lead to modifications and changes within a short time without prior notice.

BECAUSE CONDITIONS OF USE ARE OUTSIDE OF HABASIT'S AND ITS AFFILIATED COMPANIES' CONTROL, WE CANNOT ASSUME ANY LIABILITY CONCERNING THE SUITABILITY AND PROCESS ABILITY OF THE PRODUCTS MENTIONED HEREIN. THIS ALSO APPLIES TO PROCESS RESULTS / OUTPUT / MANUFACTURING GOODS AS WELL AS TO POSSIBLE DEFECTS, DAMAGES, CONSEQUENTIAL DAMAGES, AND FURTHER-REACHING CONSEQUENCES.

